

# Instruction Manual

**SUNJE**  
Electrostatics



**SXB-05NRI**

Eng

It is recommended that only persons who have sufficient knowledge and experience such as system designers and responsible persons deal with this product after carefully reading the product manual.

## 1 The matters of safety

### WARNING

- \* Do not fabricate or do maintenance by yourself. Malfunction, Electric shock, and fire danger are considered. Contact us directly if you need the item to be repaired.
- \* Do not let the water touch the product. It may cause electric shock or fire due to malfunction.
- \* When you check or maintain the product, make it sure you turn off the power. It may cause electric shock or fire due to malfunction.
- \* The item should be fixed to the target tightly. Electric discharging or breakage might happen.
- \* Please shield your installing circumstances first since the item releases the soft X-ray.
- \* Direct X-ray exposure is not recommended owing to cause health problem
- \* It includes a beryllium window on the X-ray tube unit in order to release soft x-ray for ionization. This beryllium material can cause respiratory disorder only if the person gets exposed to forms of either beryllium powder or smoke. However, our device doesn't create beryllium in neither of the mentioned forms. Please be careful not to break the device since there might be a slight chance that the device could partially degrade into the powder form, then it can cause harm defects. If the user touches the beryllium material on the device, clean oneself on the running water or rinse it off with soap directly. If the beryllium window gets dirty or damaged, call us directly for assistance.
- \* Do not use the product at the place where dangerous material such as inflammable or ignitable material exists. This product is not the product of anti-explosive type.
- \* This device is made only for industrial uses. You need to ground the device beforehand. Otherwise, there are in case of malfunction, electric shock, or fire damage.

### CAUTION

- \* Do not disconnect the output cable with power applied. There is a possibility of electric shock or malfunction.
- \* Connect wires referring to the product manual. Wrong connection can cause failures.
- \* For your proper cable connection, take a look at the manual 'Installation & Connection,' for references. Any disordered connection is detected, the malfunction might arise.
- \* All cables should be connected all the time. Please careful of cable disconnections. If power or communication cables got damaged, replace them immediately. Malfunction and fire danger may happen.
- \* Do not install the device where the vibration can be detected. Any minor impact or vibration on the device, the malfunction or danger of accident might happen.
- \* Do not use the item off the range of usage(Electrostatic elimination). Malfunction or danger of accident may occur.

## 2 Check the package contents

### Product compositions

The package includes the following products composition.

Bar Soft X-Ray Ionizer  
SXB-05NRI-\*\*\*\*\*  
1ea

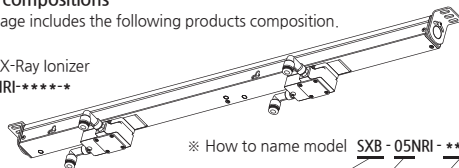

※ How to name model **SXB-05NRI-\*\*\*\*\***

Bar Name	Tube Voltage Value	Bar Length	Number of Tube
e.g. : SXB - 05NRI - 1200 - 4			

### Option

If you require extra functions with the basic accessories we provided, you need to purchase optional items in below for further assistant.

<Replacement Parts>	<Middle Bracket>	<Boost Module>	
 * Tube SXB-05NRI-T	 * Middle Bracket SBR-XB-1-001	 * Boost Module SXB-BM	 * Output Cable SOC-XN-6-001 10m / 1ea

## 3 Nomenclatures of parts

### Bar Soft X-Ray Ionizer (SXB-05NRI Series)

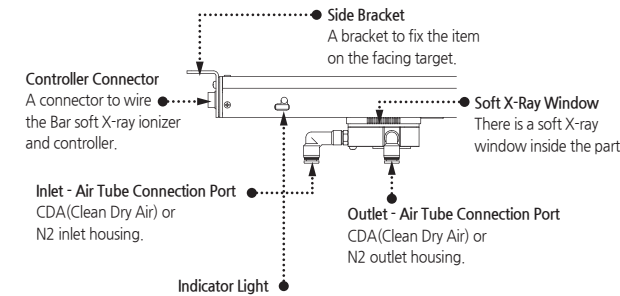

**Indicator Light**

- Green LED will be turned on when the product is in operating condition.
- When false operation, red LED will be turned on.
- Orange LED will be turned on when the lifetime of X-ray tube is exceeded.

If the product is operated continuously after arrival of the replacement cycle, then the orange and green LED will be turned on sequentially.

### Boost Module (SXB-BM)\_Option

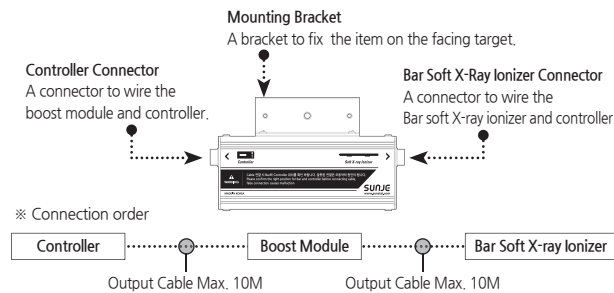

## 4 Installation and connection

### Check the installation conditions Bar soft X-ray ionizer

Please check the installation condition whether it meets proper specification.

- Shielded Room
- There must be no objects between the target area and X-ray device.
- No vibration on the fixed device.
- Be aware of any flammable or ignitable materials around the working area.
- Secure to have enough working space for quick maintenance of the device.

### Bar soft X-ray ionizer installation

#### Basic Installation

Please fixing firmly to wall or rack by M4 bolts on side bracket.

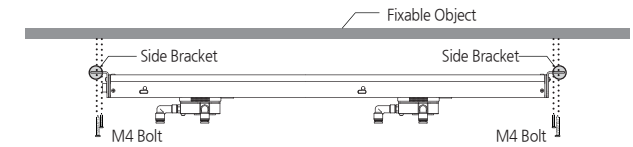

#### Installation by Middle Brackets (Option)

If Bar soft X-ray ionizer cannot be installed using side bracket, it is recommended to install it using middle bracket. Please fix the middle bracket with M4 Bolts.

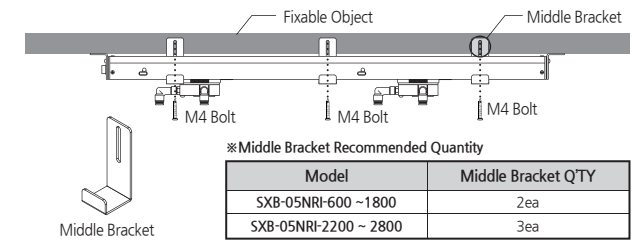

※Middle Bracket Recommended Quantity

Model	Middle Bracket Q'TY
SXB-05NRI-600 ~1800	2ea
SXB-05NRI-2200 ~ 2800	3ea

### Shielding method

#### Shielding Material Selection

See the following graph for references. Select the ideal tickness and quality of shielding material.

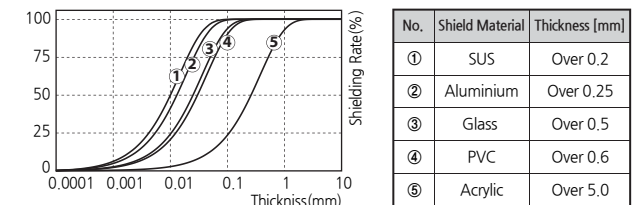

**WARNING**

- \* Please shield the area where the customer is willing to install the soft X-ray device for safety issue.
- \* After shielding process, please connection to your own interlock system to operate the soft X-ray device on/off when the door is opened/closed.

### Shield installation compositions

Please refer to the "Installation Compositions" for your references. Please keep your working environment of the leakage radiation level within the range of 1μSv/hr all the time.

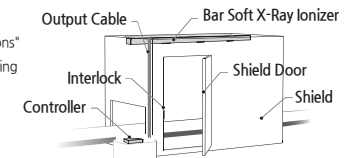

## 5 Maintenance

**WARNING**

- \* This device uses the high level of voltage. When operating maintenance, please power off and unplug the device. Otherwise, there might be in case of electric shock or fire damage.

### Maintenance

X-ray type ionizer has own service life. The replacement is required after the service life.

Tube Replacement

If there are any malfunction or lifetime excess on the tube, please purchase the new tube and replace it according to the following procedure.

**CAUTION**

- \* Please do not operate the product when the tube is disconnected. It may cause electric shock or fire due to malfunction.
- \* When tube operates, heat is generated. Product is hot right after operation, so be careful not to touch it. There is a risk of burn.
- \* A H/V connector of tube is protruded. After unscrew the bolts, pull the unit vertically. Please be careful when replacing H/V connector.
- \* After replacement, check if tube and Head body are connected correctly. Unless they are connected properly, ground could be unstable.
- \* If the fixing bolt is not mounted, it can cause abnormal operation or defective issue. Make sure that the bolt is mounted before using it.
- \* Do not unscrew any bolts other than fixing bolts. If unscrewed, it can occur fire, electric shock, and breakages.

① Unscrew a Fixing Bolt

Using X-head screwdriver, turn the bolts to counterclockwise to release.

② Pull out the tube

After loosen the tube fixing bolt and pull the tube downward.

③ Separating Tube

Separate the tube by pulling it downwards.

You can dispose of the tube by yourself or make a contact to SUNJE.

④ Replacing New Tube

After checking the direction of the high voltage connector of the new tube, insert it in the vertical direction and assemble in reverse.

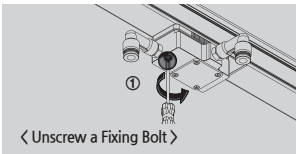

< Unscrew a Fixing Bolt >

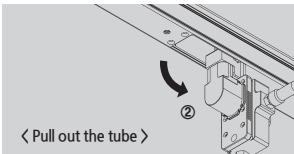

< Pull out the tube >

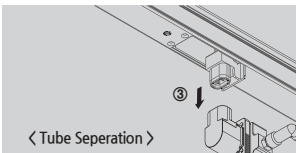

< Tube Separation >

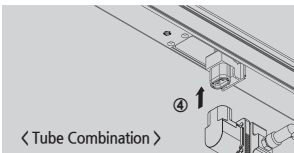

< Tube Combination >

※ After replacing the Tube, run "Tube Reset" on the controller. If the reset process is not performed, the replaced tube will not work.

6 Problem solving

▶ Checklist before called

Problem	Identifying Problem	Solution
Not operating	Is your power cable still plugged in?	Please re-plug the power cable and then turn the device on again.
	Was the proper voltage level applied for this set-up?	Please use the proper level of power input for the device. (AC 100~240V, 50/60Hz)
	Is the switch off at back of the controller?	Turn on the power switch.

Not operating	Is a fuse broken?	Replace the proper fuse immediately.
	Is there tube replacement LED on the device?	Purchase and replace the tube unit(replaceable).
	Is remote off?	Clear the remote off corresponding to "Remote Setup" manual.
	Is Interlock off?	Place Interlock on corresponding to "Interlock setup" manual.
No signal	Have you followed the proper procedure for input/output signal cable(s)	Check whether the cable connection is properly done.
Decreased Performance	Can't possibly ground the device?	Please refer to "Installation & Connection" for (proper) grounding the device.
	Any damages or cut on the cables?	You need to replace the cables if it gets cut or damaged.

7 Dimensions

▶ Bar soft X-ray ionizer (SXB-05NRI Series)

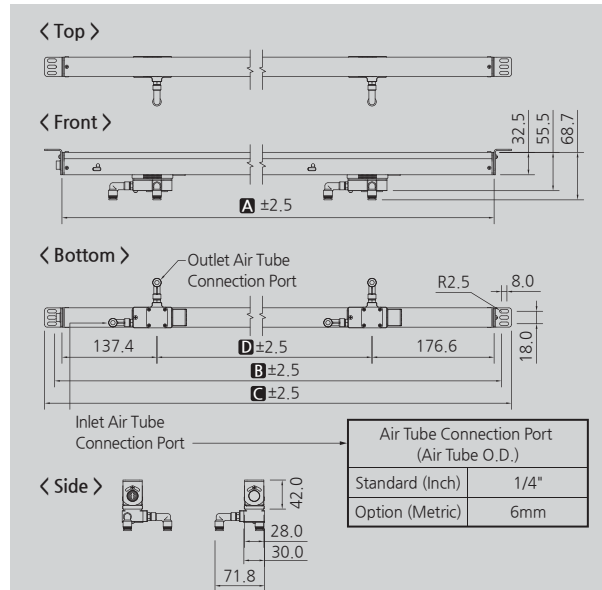

No.	MODEL No.	A	B	C	D	TUBE QTY
1	SXB-05NRI-300-1	314	335	364	-	1
2	SXB-05NRI-600-2	625	646	675	311	2
3	SXB-05NRI-900-3	936	957	986		3
4	SXB-05NRI-1200-4	1247	1268	1297		4
5	SXB-05NRI-1500-5	1558	1579	1608		5
6	SXB-05NRI-1800-6	1869	1890	1919		6
7	SXB-05NRI-2200-7	2180	2201	2230		7
8	SXB-05NRI-2500-8	2491	2512	2541		8
9	SXB-05NRI-2800-9	2802	2823	2852		9

※ The Air Tube Connection Port is applied in standard 1/4" Inch size, but if there is a desired size, it can be selected as an option.

▶ Middle Bracket

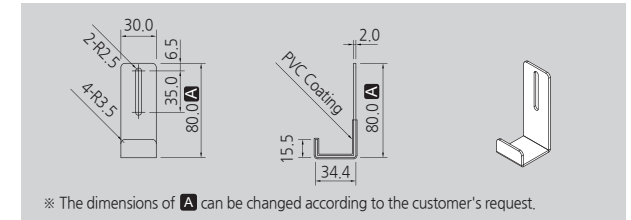

▶ Boost Module (Option)

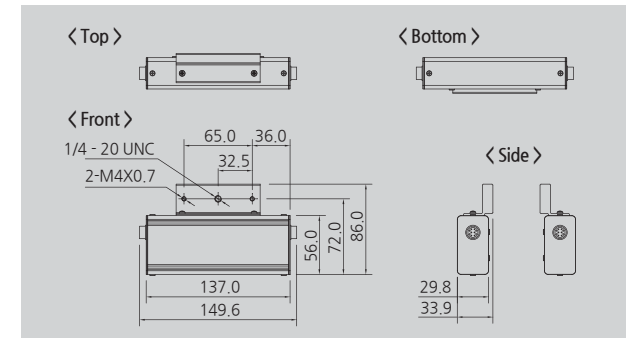

8 Specification

Parameter	Description / Value
Ion Generation Method	Soft X-ray
Source	Soft X-ray Tube
Tube Voltage	4.9kV
Beam Angle	150°
Power Consumption (with Controller)	Max. 150W
Operation Circumstance	0°C ~ +50°C(32°F ~ 122°F), 35% ~ 85% RH
Controller	SXC-10BT / SXC-10BL Series only (Can not compatible with other controllers)
Warranty	1 year

※ The appearance and specification of the product may be changed without prior notice for the improvement of the product.

SUNJE Electrostatics

www.sunstat.com

▶ Head Office & Factory (Busan)

8 Cheonggwang-gil, Ilgwang-Myeon, Gijang-Gun, Busan, Korea  
T) +82-51-720-7500 F) +82-51-720-7501

▶ Sunje Japan Co., Ltd.

Dai 7 Matsuya Bldg 10F 1005 2-23, Honmachibashi, Chuo-ku, Osaka, Japan  
T) +81-6-6949-5001 F) +81-6-6949-5011

▶ Sales Headquarter (Osan)

795 Naesammi-dong, Osan-si, Gyeonggi-do, Korea  
T) +82-31-203-9034 F) +82-31-202-9034

▶ Sunje (SHANGHAI) Trading Co., Ltd.

Block C, 4F, No.482, Hongxu Road, Minhang District, Shanghai, China  
T) +86-21-5433-9761 F) +86-21-5433-9762

Customer Center +82-70-7714-9033  
Sales Contact +82-31-203-9034

▶ Sunje Technology Co., Ltd.

2F, No.6, Lane.102, Sinhe Rd, Sinfong Township, Hsinchu County, Taiwan 30472  
T) +886-3-568-7891 F) +886-3-568-7950