

Instruction Manual

SUNJE

SIB5S-C Series

RU US Eng

It is recommended that only persons who have sufficient knowledge and experience such as system designers and responsible persons deal with this product after carefully reading the product manual.

1 The matters of safety

WARNING

- * If the equipment is used in a manner not specified by the manufacturer, the protection provided by the equipment may be impaired.
- * Do not let the water touch the product. It may cause electric shock or fire due to malfunction.
- * When you check or maintain the product, make it sure you turn off the power. It may cause electric shock or fire due to malfunction.
- * Secure the product firmly when you want to secure it. There is a possibility of accident due to fall-over or malfunction, etc.
- * Secure working space when you install the product. If working space is not secured, the checking or maintenance of the product is made impossible leading to failure of the product.
- * Always use either one of the following materials for air supply: CDA(Celan Dry Air) or N2. If there are any water or oil contamination in the air supply, it will cause malfunction or cause of accident.
- * Do not use the product at the place where dangerous material such as inflammable or ignitable material exists. This product is not the product of anti-explosive type.
- * This device is made only for industrial uses. You need to ground the device beforehand. Otherwise, there are in case of malfunction, electric shock, or fire damage.

CAUTION

- * Do not contact the discharge needle or terminal with power applied. There is a possibility of electric shock or malfunction.
- * Handle the discharge needle with care as its tip is very sharp.
- * Connect wires referring to the product manual. Wrong connection can cause failures.
- * Take precautions as cables of the adaptor, the power line and communication line of each product may disconnect. If the cable is damaged, replace it immediately.
- * Do not install the device where the vibration can be detected. Any minor impact or vibration on the device, the malfunction or danger of accident might happen.
- * Do not use the product for the purpose outside of the range of the product use. If the product is used for the purpose outside of the range of the use, it can result in the trouble or the shortened service life. Or an unexpected problem may occur.
- * The ionizer generates ozone(below 0.05ppm) if you sense the smell of ozone when you use more than two units, ventilate the air.
- * When installing or transporting the ion bar, be prepare not to bend the item during the process.

2 Check the package contents

Product compositions

The package includes the following products composition.



Ion Bar
SIB5S-C
1ea

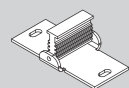

Middle Bracket
SBR-SC-2-001
0~2ea

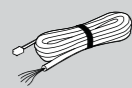

Power Cable
SUC-3R-3-001
5m / 1ea

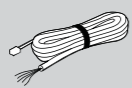

Signal Cable
SUC-MT-2-001
5m / 1ea

Option

If you require extra functions with the basic accessories we provided, you need to purchase optional items in below for further assistant.

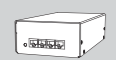

DC Power Supply
SBP-RD

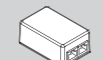

Ion Bar Gender
SBG-5C3

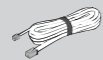

UTP Cable (5m)
SUC-B3-1-001

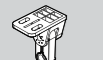

Side Bracket
SBR-B4-1-001



Middle Bracket
SBR-B4-2-001



UTP Cover
SUC-MT-1-001

3 Nomenclatures of parts

Ion Bar (SIB5S-C Series)

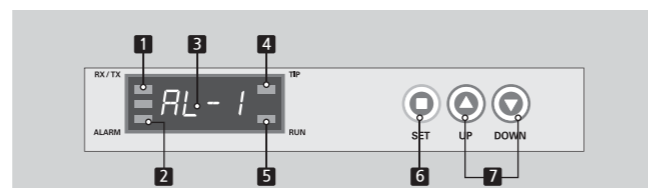
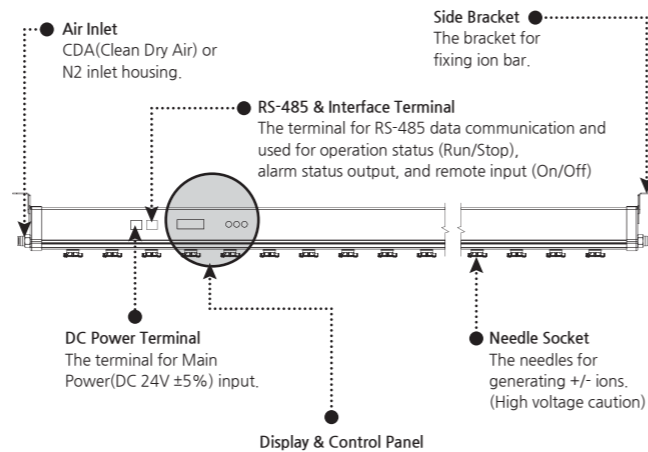

NO	Name	Function
1	RX / TX (LED)	Light on when using RS-485.
2	Alarm (LED)	Light on when Alarm occurs.
3	FND Display	<A-01 ~ 16> : Address <AL-1> : When high voltage error, display and operation stop. <AL-2> : When over-discharge of electrode or leakage occurs, display and operation stop. <AL-3> : When tip cleaning setting time is over.
4	Tip Cleaning (LED)	Light on when tip cleaning setting time is over.
5	RUN (LED)	Ion Bar Lights up during normal operation.
6	SET Button	It is for changing the address, frequency Setting.
7	Up / Down Button	

※ When an alarm occurs, product operation stops.
If the operation stops, turn the product off and then on.

DC Power Supply (SBP-RD)_Option

The SBP-RD is a DC 24V power supply for SIB5S-C Series. When there is not a power source for DC 24V on an installation point or equipment, it can supply DC 24V to SIB5S-C Series and be connected up to Max. 4sets.

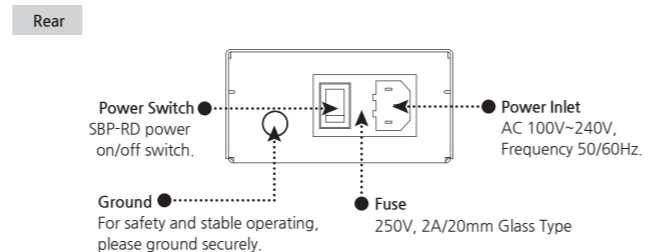
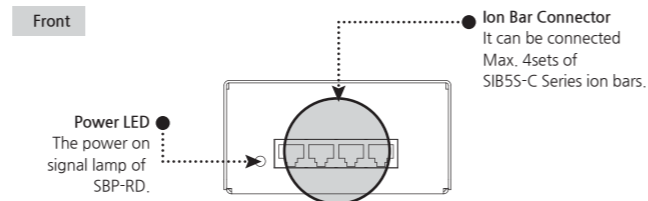

4 Installation and connection

Ion bar installation

When you install SIB5S-C Series ion bar, please check the distance between ion bar and object.
※ Please, handle with care when you carry or install not to break or bend an ion bar.

CAUTION

* The radius of curvature of the air hose is Install with R10mm or more for operation. (Due to excessive bending of the air hose The product may be damaged.)

Basic Installation

Please, firmly fix to wall or rack and brackets and middle bracket which are provided as accessories by M4 or M5 bolts.

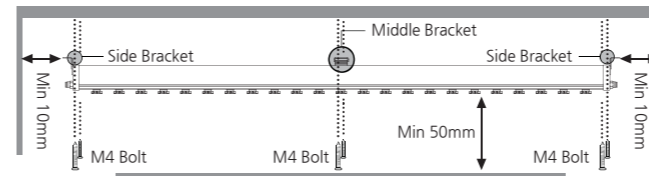

Interference by Grounding Matters

If there is any conductive object close to ion bar, SIB5S-C Series may not operate properly. Please install it with reference to figure below.

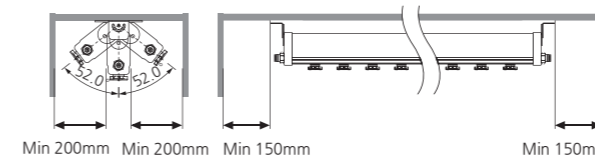

Side to Side Installation

When the more than two ion bars are installed, to avoid interference, the range between two ion bars should be more than 400mm.

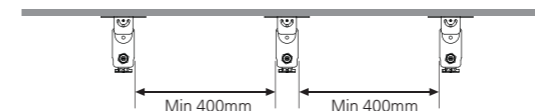

Face to Face Installation

When two ion bars are installed face to face, to avoid interference, the range between two ion bars should be more than 100mm. (Air Pressure Under 0.1MPa)

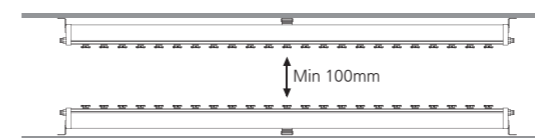

Installation by Middle Brackets

The middle bracket is used to protect bending problem by the weight of ion bar. Please fix the middle bracket with M4 or M5 bolts. The number of supporting middle bracket will differ from the models.

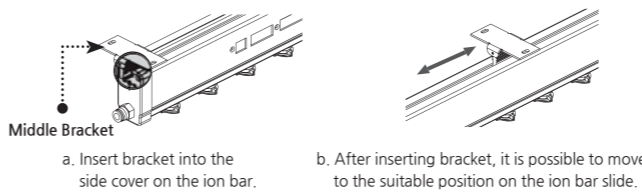

Air supply method

● CAUTION

- * Air supply is one of the key factors. Please read the followings carefully in advance.
- * Please contact us directly if you periodically switch to use air in/out time after time.
- * If many ion bars are connected to one air line, with air lack of pressure, it may have difficulty to provide proper performance.

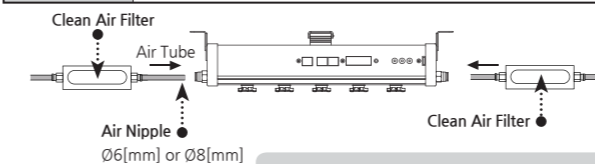

※ Please use the proper air filter for your working environment. [We suggest you to use a clean air filter(Filteration : 0.01µm) for clean environment.]

Types of Air Use

Please supply air into an ion bar either one of CDA(Clean Dry Air) or N2 if possible. In the clean environment, we suggest you to use a clean air filter(Filteration:0.01µm) in order to pass impurities in the compressed air through the filter when using the ion bar.

Allowed Air Pressure

The maximum air pressure level for SIB5S-C Series is 0.5MPa. Try not to exceed the maximum level when supplying air. Since the air pressure has some relation with ionization performance, fully consider the proper air pressure level for your environment.

Air Nipple

Please use to connect Ø6[mm] or Ø8[mm] nipple for air inlet, but the standard is Ø8[mm].

Recommended Model (For Clean Nipple)

Material	Shape	Tube Size	Screw Size
Polypropylene (PP)	Straight or Elbow	Ø8 or Ø6[mm]	Taper Screw 01 (R1/8)

※ Clean nipples are made from plastic, so be careful not to damage them by impact.

The installation with DC Power Supply SBP-RD

The Installation with SBP-RD

The SBP-RD can supply DC 24V to SIB5S-C Series and be connected up to Max.4sets. The power cable length is max.5m. It is not able to have normal performance if longer than 5m.

Parallel Power Connection Function

SIB5S-C Series can be connected up to Max.4 ion bars by parallel power connection function.

It can be connected up to Max.5m. If it is not, it might have not normal performance. ※ When supplied power by SBP-RD, regardless of the power connection methods, the total number of ion bars with one SBP-RD should not exceed 4 sets and remainder sockets should be plugged up a cap.

Interface

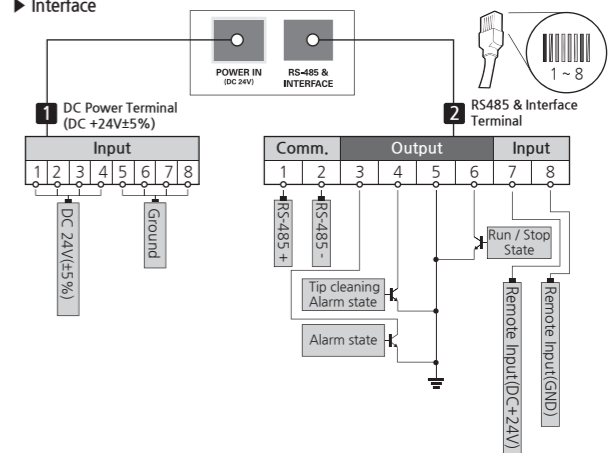

1 DC Power Terminal (DC +24V ±5%)

No	Color	Function
1	Brown	DC 24V (±5%)
2	White & Brown	
3	Orange	
4	White & Orange	
5	Green	Ground
6	White & Green	
7	Blue	
8	White & Blue	

2 RS-485 & Interface Terminal

No	Color	Function	Output	Picture
1	Brown	RS-485+	-	-
2	White & Brown	RS-485-	-	-
3	Orange	Alarm State	Photo Relay Output (Normal-Open, Alarm-Close)	Normal Alarm
4	White & Orange	Tip cleaning Alarm state	Photo Relay Output (Normal-Open, Alarm-Close)	Normal Alarm
5	Green	Common	-	-
6	White & Green	Run / Stop State	Photo Relay Output (Run-Close, Stop-Open)	Run Stop
7	Blue	Remote Input (DC+24V)	DC+24V	-
8	White & Blue	Remote Input (GND)	Ground	-

※ Remote stops when Input signal(DC24V) is applied.

Power Input (DC 24V)

The terminal for main power(DC 24V ±5%) input. Please make sure that main power has to connect with designated interface terminal.

CAUTION

※ If it connects to RS-485 & Interface Terminal, it has malfunction.
※ Power cable cap is yellow.

RS-485 & Interface Terminal

The terminal for RS-485 data communication and used for operation status(Run/Stop), alarm status output(Over current Alarm, Tip cleaning timer Alarm), and remote input(On/Off)

▶ Connection with PC
It is possible to control the Run/Stop, Alarm, Remote On/Off operation of the SIB55-C Series by using a computer. (Max.16ea)



▶ Circuit

Circuit(Photo Relay Output)

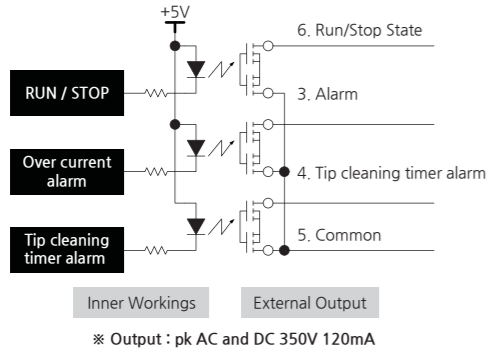

Circuit(DC 24V Input)

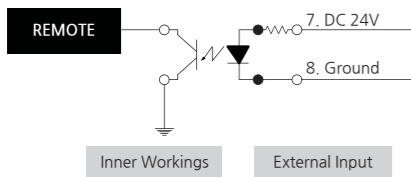

5 How to set

Setting Order

In the main body of ion bar, you can easily set Address, Frequency, Duty, Pulse, Tip Clean Mode on/off and Tip Cleaning Time Set up.

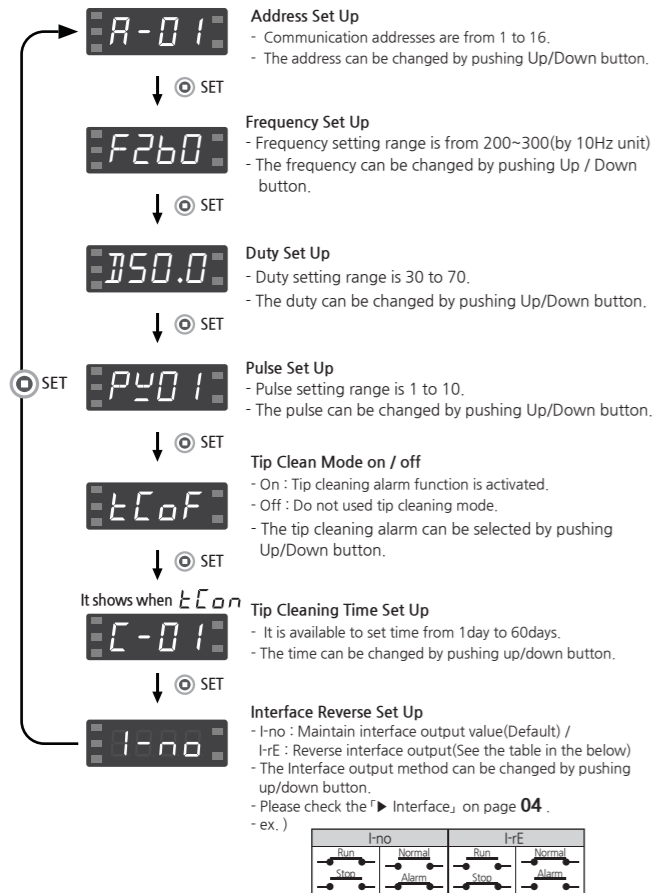

* Once your setup is done, the device will automatically save your current setup value immediately(within 5 second).

6 Maintenance

Maintenance is an essential item for maintaining its capacity. Please conduct a routine maintenance according to the below description. The life time of a discharge needle can be a difference depending on using circumstance.

CAUTION

- This device uses the high level of voltage. When operating maintenance, please power off and unplug the device. Otherwise, there might be in case of electric shock or fire damage.
- The discharge needle is very sharp at the edge. Do not physically(directly) touch the discharge needle.
- When cleaning the discharge needle using an organic solvent, do not use the organic solvent to clean the socket around the discharge needle.

▶ Discharge needle cleaning

The contamination level of discharge needle is different among the areas where the user installs, please maintain own cleaning period that suits your environment.

▶ Discharge needle cleaning order

- Be sure to power off before cleaning the ionizer.
- Please clean it as the table below.

*** Cleaning with a cotton swab**
After moistening a cotton swab with alcohol, wipe the discharge needle from side to side with the swab. (do not use acetone)

- Replace the damaged discharge needle.
- After the cleaning, let the alcohol applied to the discharge needle surface evaporate completely and then operate the Ion Bar.
- Please record the cleaning process as a reference in the file.

▶ How to replace the needle socket

When replacing, please be careful not to touch the discharge needle. It is very sharp at the edge.

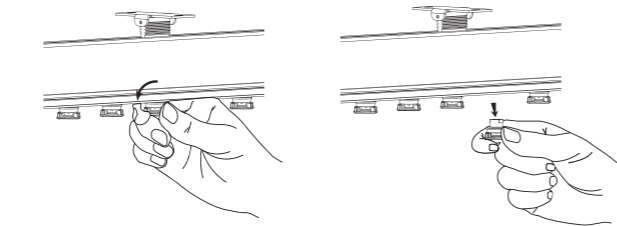

▶ Discharge needle maintenance

If the discharge needle broken or severely damaged, please replace the needle socket immediately. The needle socket becomes less durable with product usage time. To maintain the performance of the product, we recommend replacing the needle socket every one year.

7 Problem solving

▶ Checklist before called

Problem	Identifying Problem	Solution
The product does not work.	Is your power cable still plugged in?	Please re-plug the power cable and then turn the device on again.
	Was the proper voltage level applied for this set-up?	Please use the proper level of power input for the device. (AC 100~240V, 50/60Hz)
There is no ionization.	Is the switch off at back of the device?	Turn on the power switch.
	Is there any conductive material around the device?	Please refer to 「Installation & Connection」 for setting the proper target distance from the device.
The ionizing performance has been decreased.	Does the installed environment have too high/low level of humidity or temperature?	Please install the device upon the proper working specification.
	Any damages or cut on the cables?	You need to replace the cables if it gets cut or damaged.
	Any contamination on the discharge needle?	Please refer to 「Maintenance」 for cleaning the discharge needle.

8 Dimensions

▶ SIB55-C Series

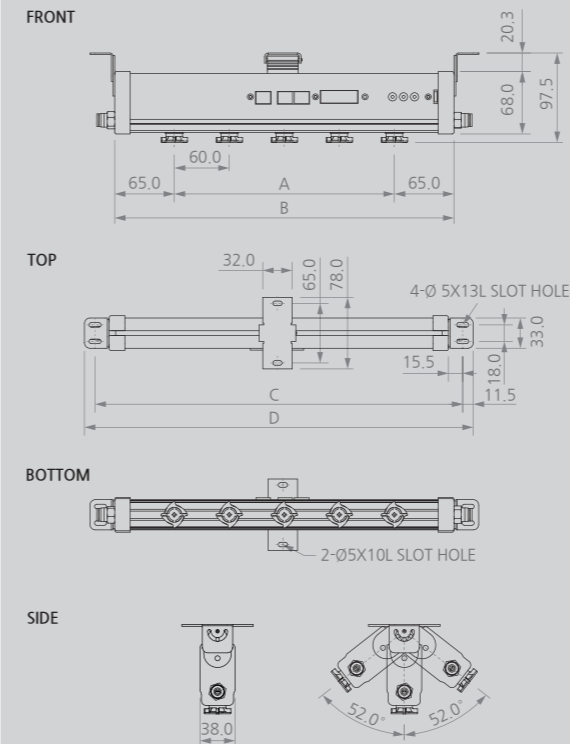

No.	Model No.	Tip Q'ty	A	B	C	D	Middle BKT Q'ty
1	SIB5-400S-C	5	240	370	401	424	-
2	SIB5-500S-C	7	360	490	521	544	-
3	SIB5-550S-C	8	420	550	581	604	-
4	SIB5-600S-C	9	480	610	641	664	-
5	SIB5-700S-C	11	600	730	761	784	-
6	SIB5-900S-C	13	720	850	881	904	-
7	SIB5-1000S-C	15	840	970	1001	1024	-
8	SIB5-1100S-C	17	960	1090	1121	1144	-
9	SIB5-1200S-C	19	1080	1210	1241	1264	-
10	SIB5-1300S-C	21	1200	1330	1361	1384	-
11	SIB5-1500S-C	23	1320	1450	1481	1504	1
12	SIB5-1600S-C	25	1440	1570	1601	1624	1
13	SIB5-1700S-C	27	1560	1690	1721	1744	1
14	SIB5-1800S-C	29	1680	1810	1841	1864	1
15	SIB5-1900S-C	31	1800	1930	1961	1984	1
16	SIB5-2100S-C	33	1920	2050	2081	2104	2
17	SIB5-2200S-C	35	2040	2170	2201	2224	2
18	SIB5-2300S-C	37	2160	2290	2321	2344	2
19	SIB5-2400S-C	39	2280	2410	2441	2464	2
20	SIB5-2500S-C	41	2400	2530	2561	2584	2
21	SIB5-2700S-C	43	2520	2650	2681	2704	2
22	SIB5-2800S-C	45	2640	2770	2801	2824	2
23	SIB5-2900S-C	47	2760	2890	2921	2944	2
24	SIB5-3000S-C	49	2880	3010	3041	3064	2

▶ SBP-RD (Option)

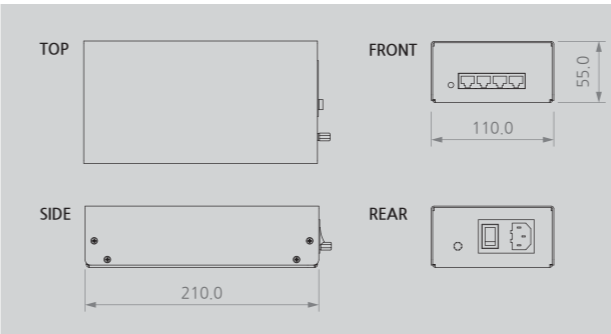

9 Specification

▶ SIB55-C Series

Parameter	Description / Value
Input Power	DC 24V (±5%)
Power Consumption	Max. 4.8W
Current Consumption	Max. 200mA
High Voltage	Pulse AC 11.5kV
Ion-Generation Method	Corona discharge Pulse AC
Structure	Capacity coupled
Connector	Power(DC24V) : RJ45 RS-485 & Interface : RJ45
Operating Distance	50~2,000mm
Air Purge Supply Pressure	0.1 ~ 0.5MPa (CDA, N2[Need to be no dew condensation])
Operation Circumstance	0°C ~ +50°C(32°F ~ 122°F), 35% ~ 85% RH
Ozone(O3) Concentration	≤0.05ppm
Main Body Material	Non-Flammable ABS (Level V0)
Electrode Material	Standard : Tungsten Option : Silicon / Titanium
Electrode Replacement	Cartridge type
Model Line Up	400mm~ 3000mm
Function	Alarm Over Discharge Alarm Tip Cleaning Timer Alarm
	Interface - Run/Stop State : Run-Closed / Stop-Open - Over Discharge Alarm : Normal-Open / Alarm-Closed - Tip Cleaning Timer Alarm : Normal-Open / Alarm-Closed - Remote Input : DC 24V (15mA)
Communication	RS485
Option	SBP-RD (DC Power Supply)
Warranty	1 year

* Product model number will be differ as the discharge needle specifications.
ex. Tungsten : SIB5-****S-C / Silicon : SIB5-****S-C-SI / Titanium : SIB5-****S-C-TI
* The appearance and specification of the product may be changed without prior notice for the improvement of the product.

CAUTION + Handle with care. Warranty doesn't cover mishandling damage.

▶ SBP-RD

Parameter	Description / Value
Input Power	AC 100~240V, 50/60Hz
Power Consumption	Max. 80W
Weight	1.85kg
Main Body Material	EGI
Operation Circumstance	0°C ~ +50°C(32°F ~ 122°F), 35% ~ 85% RH
Output Voltage	DC 24V Max. 3A
Output Port	4 Ports
Warranty	1 Year

* The appearance and specification of the product may be changed without prior notice for the improvement of the product.

▶ Reliability Test & Certificate

Reliability Test	Environmental Test (IEC60068-2)
	Durability Test (IEC61010-1) Other self-regulation test
Certificate	COC : CE (TUV NORD)
	DOC : ISO Extended Class 1 (KSI ISO 14644-1)

SUNJE Hi-Tek Co., Ltd.

www.sunstat.com

Head Office & Factory (Busan)
8 Cheonggwang-gil, Ilgwang-eup,
Gijang-Gun, Busan, Korea
T) +82-51-720-7500 F) +82-51-720-7501

Sunje (SHANGHAI) Trading Co.,Ltd.
205B, Building A, No.1018 Mingzhu Road,
Qingpu District, Shanghai, China
T) +86-21-5433-9761 F) +86-21-5433-9762

Sales Headquarter (Osan)
3rd floor, 129-20, Gyeonggi-daero 632
beon-gil, Osan-si, Gyeonggi-do, Korea
T) +82-31-203-9034 F) +82-31-202-9034

Sunje Technology Co., Ltd.
2F, No.6, Lane.102, Sinhe Rd, Sinfong
Township, Hsinchu County, Taiwan 30472
T) +886-3-568-7891 F) +886-3-568-7950

Customer Center +82-70-7714-9033 **Sales Contact** +82-31-203-9034