

It is recommended that only persons who have sufficient knowledge and experience such as system designers and responsible persons deal with this product after carefully reading the product manual.

**1 The matters of safety**

**WARNING**

- \* If the equipment is used in a manner not specified by the manufacturer, the protection provided by the equipment may be impaired.
- \* Do not let the water touch the product. It may cause electric shock or fire due to malfunction.
- \* When you check or maintain the product, make it sure you turn off the power. It may cause electric shock or fire due to malfunction.
- \* Secure the product firmly when you want to secure it. There is a possibility of accident due to fall-over or malfunction, etc.
- \* Do not use the product at the place where dangerous material such as inflammable or ignitable material exists. This product is not the product of anti-explosive type.
- \* This device is made only for industrial uses. You need to ground the device beforehand. Otherwise, there are in case of malfunction, electric shock, or fire damage.

**CAUTION**

- \* Do not contact the discharge needle or terminal with power applied. There is a possibility of electric shock or malfunction.
- \* Handle the discharge needle with care as its tip is very sharp.
- \* Connect wires referring to the product manual. Wrong connection can cause failures.
- \* Take precautions as cables of the adaptor, the power line and communication line of each product may disconnect. If the cable is damaged, replace it immediately.
- \* Do not install the device where the vibration can be detected. Any minor impact or vibration on the device, the malfunction or danger of accident might happen.
- \* Do not use the product for the purpose outside of the range of the product use. If the product is used for the purpose outside of the range of the use, it can result in the trouble or the shortened service life. Or an unexpected problem may occur.

**2 Check the package contents**

**Product compositions**

The package includes the following products composition.

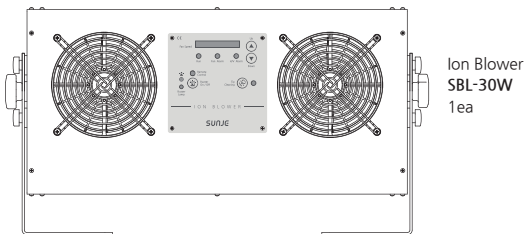

Ion Blower SBL-30W 1ea

- Power Cable SPC-MT-1-001 AC 100V, 50/60Hz, 1.8m / 1ea
- Ground Cable SGC-MT-6-001 1m /Ø6-Ø4[O Type] / 1ea
- or
- Power Cable SPC-MT-2-001 AC 220V, 50/60Hz, 1.8m / 1ea
- Signal Cable SUC-MT-2-001 5m / 1ea

**Option**

If you require extra functions with the basic accessories we provided, you need to purchase optional items in below for further assistant.

- Remote Controller SBL-RC2
- UTP Cable SUC-B3-1-001 5m

**3 Nomenclatures of parts**

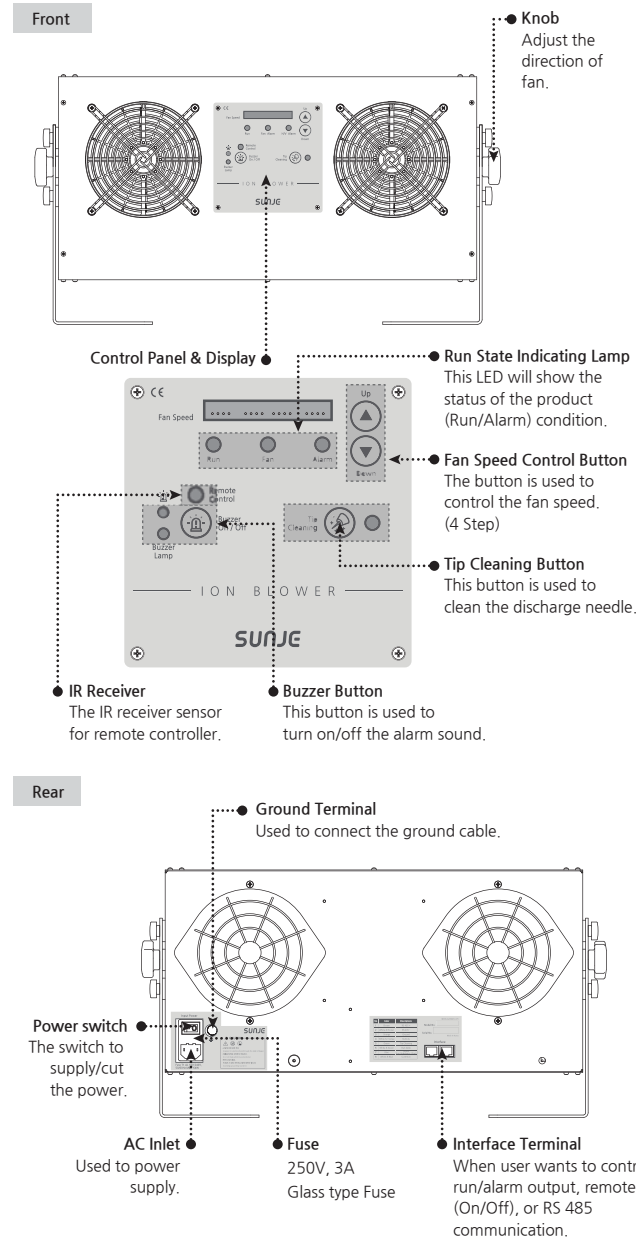

**4 Installation and connection**

**WARNING**

- \* Please adjust the device in the proper position upon the area you install. The item should be laid on the flat surface.
- \* When installing the device, please be aware of high temperature/humidity.
- \* If there are any random objects that are closely surrounded or touched the target object, the ionizing performance might decrease. Please consider the area where you install.
- \* The performance of device will decrease if the ground is insecurely connected. The proper ground connection is always a first thing to consider.

**Caution for installation**

**How to basic installation**

When installing products, you should leave a space of minimum 30mm on both sides and minimum 100mm on the back.

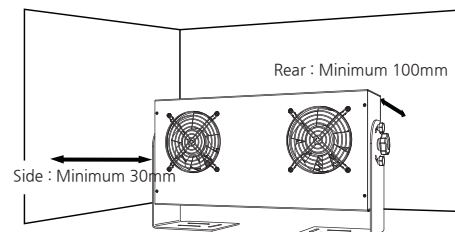

**When installing more than two units**

When installing more than two units of SBL-30W, leave a space of minimum 100mm between products.

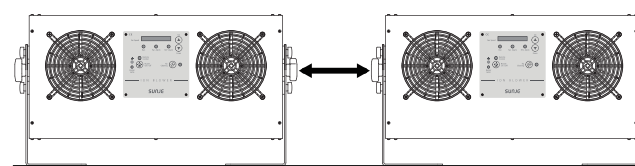

Between SBL-30W : Minimum 100mm

**Installation against the target of de-electrification**

Install the product with the distance of more than 100mm. When installed within 100mm, the phenomenon of reverse electrification can occur.

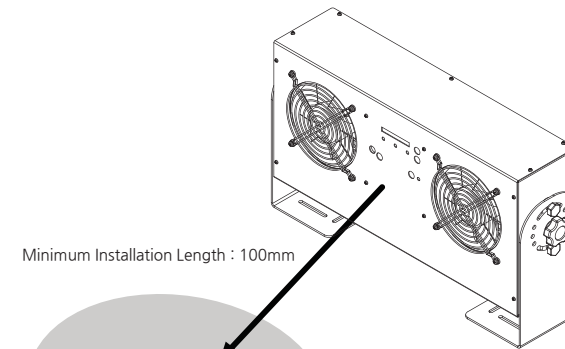

**Mounting method**

Fix the mount at the place where you want the SBL-30W to be fixed using Ø6mm bolts.

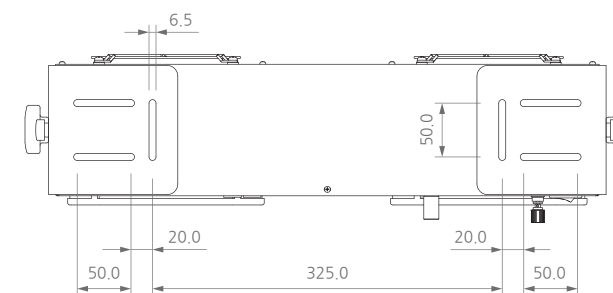
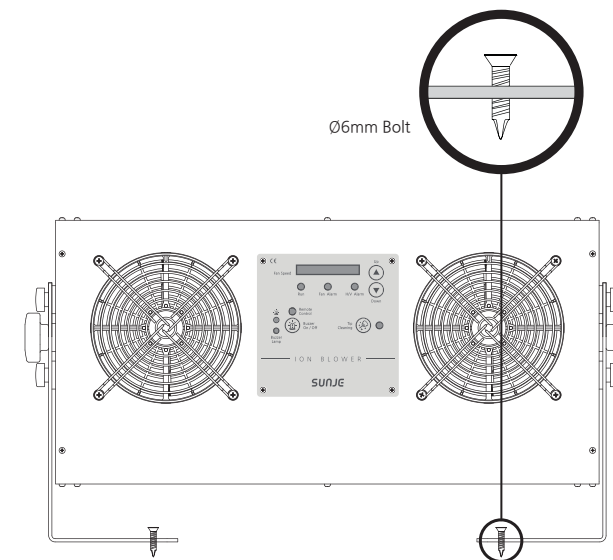

**How to connect**

Refer to the figure below to connect the product.

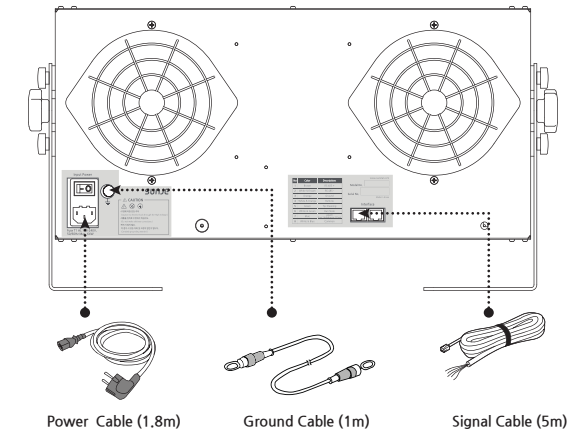

※ Be sure to ground the body of SBL-30W in order to secure the stable performance of the product and to prevent electric shock. Connect the signal cable when you want to output on the outside. The input power of the power adaptor is AC 100~240V, 50~60Hz.

**How to connect the Interface (Signal Cable)**

For the specification of the signal cable to be used, refer to the table below.

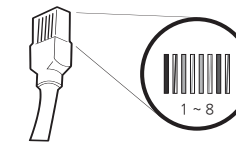

No	COLOR	Descriptions	Remarks
1	Brown	RS 485 +	RS 485 Communication (Run,Stop,Tip Cleaning Signal)
2	White & Brown	RS 485 -	
3	Orange	Ground	-
4	White & Orange	Remote	If the #4 and #3 pins are short-circuited, the product stops operating
5	Green	Tip Cleaning	The tip cleaning motor is rotated when #5 & #3 pins are closed more than one second
6	White & Green	Run State	When #6 & #8 pins are closed, SBL-30W is working
7	Blue	Alarm (Ion Unbalance / Fan)	When #7 & #8 pins are closed, SBL-30W is signaled alarm
8	White & Blue	Common	-

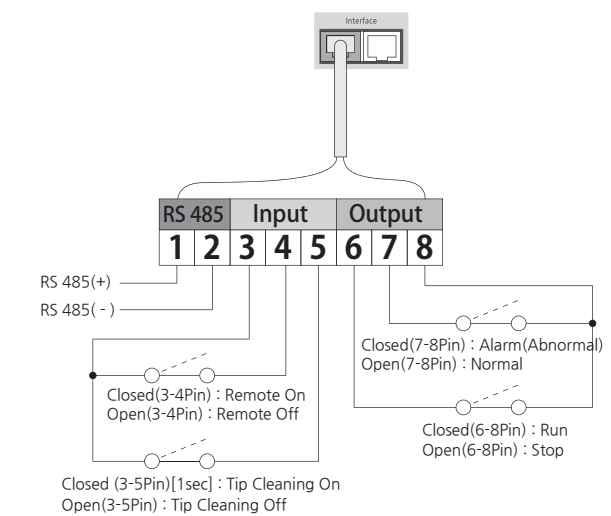

► Input / Output

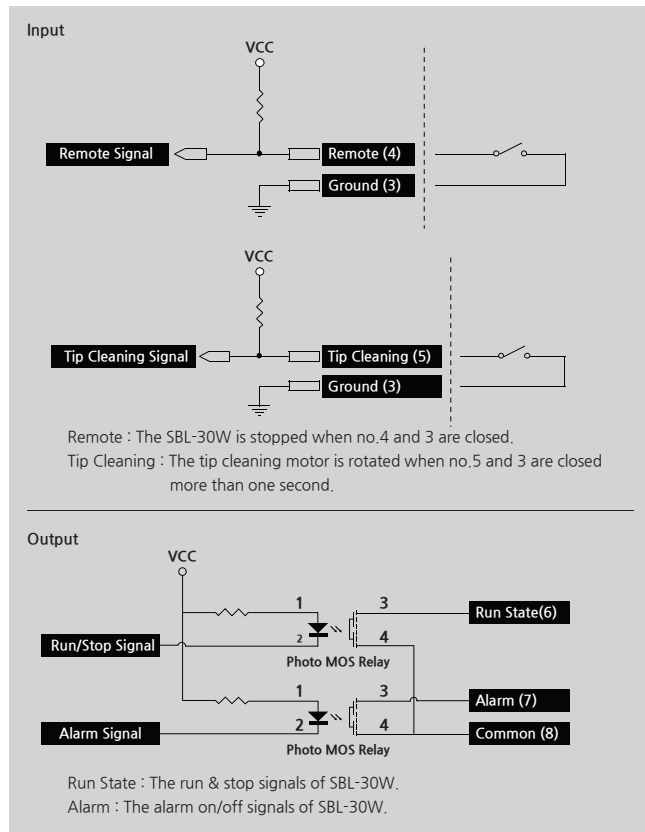

► Connection with PC

It is possible to control the run/stop, alarm and tip cleaning operation of the SBL-30W by using a computer.

The method of connecting to computer using RS-232/RS-485 Converter

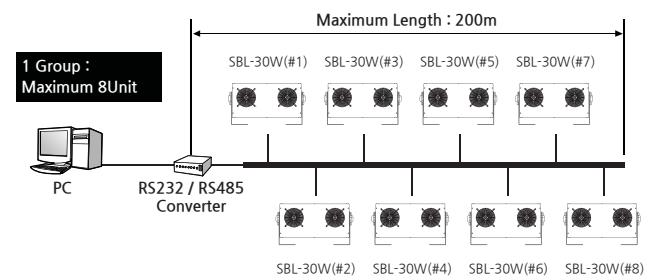

The method of connecting to computer using Multi-Port

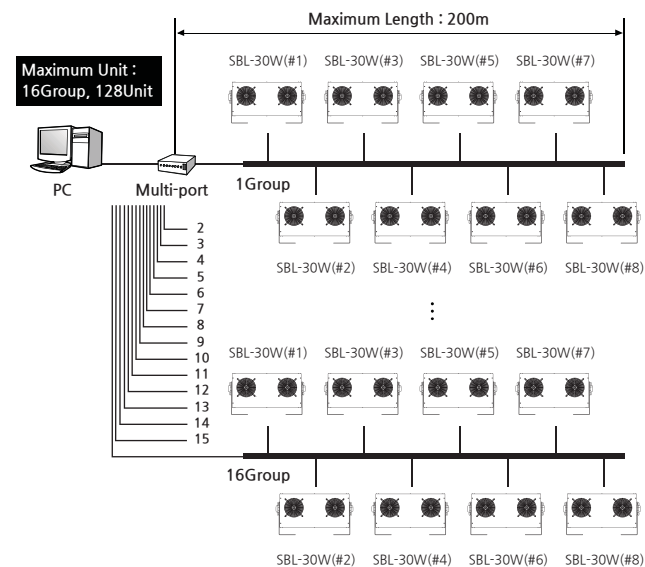

► Address Setting

1. Wait for 10 sec after turning on.
2. You can access Address setting when you press Up/Down button at the same time.
3. Depending of the number of LED on, you can check selected Address.  
8 7 6 5 4 3 2 1
4. You can set up the Address using UP, DOWN button.
5. If there is no move during 3 sec, selected Address will be used and setting mode finishes.

5 Maintenance

Maintenance is an essential item for maintaining its capacity. Please conduct a routine maintenance according to the below description. The life time of a discharge needle can be a difference depending on using circumstance. SBL-30W needs a routine maintenance and cleaning in case of bad circumstance.(high humidity or dust) Therefore, the discharge needle is recommended to be cleaned regularly.(At least once a month)

**CAUTION**

- \* This device uses the high level of voltage. When operating maintenance, please power off and unplug the device. Otherwise, there might be in case of electric shock or fire damage.
- \* The discharge needle is very sharp at the edge. Do not physically(directly) touch the discharge needle.
- \* Do not remove the front cover(Grill) when the product is operating. There is a risk of electric shock and accident.

► Tip cleaning

Tip Cleaning Button

SBL-30W has a brush to clean a discharge needle. When the "Tip Cleaning" button on the front is depressed, SBL-30W will clean the discharge needle automatically for 5 seconds after fan's operation is stopped.

Auto Tip Cleaning

If the power on status of the SBL-30W last more than 24 hours, it will automatically clean a discharge needle every 24 hours. Discharge needle cleaning is executed for 3 seconds after fan's operation is stopped.

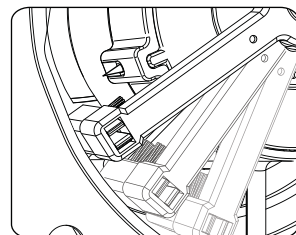

Manual Tip Cleaning

- Clean a discharge needle in person in case of its serious contamination.
- Be sure to power off before cleaning the ionizer.
  - Please open the rear cover of a SBL-30W.
  - Soak the cotton swab with alcohol.(do not use acetone)
  - Put the swab on the discharge needle and wipe it turning the swab right and left. (take precautions not to apply severe force to the discharge needle)
  - Replace the damaged discharge needle.
  - After the cleaning, let the alcohol applied to the discharge needle surface evaporate completely and then operate the SBL-30W.
  - Please record the cleaning process as a reference in the file.

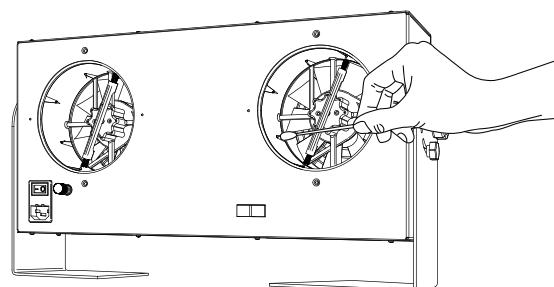

► The cycle of replacing the electricity removal discharge needle

- Check during the discharge needle cleaning and take action.
- Replace the broken or severely damaged discharge needle.
  - You can directly replace the discharge needle using a long nose wrench or similar. When replacing, please be careful not to touch edge of the needle it might break easily.
  - The discharge needle is very sharp at the edge. Do not physically(directly) touch the discharge needle.
  - The general cycle of needle replacement is one year, however, it can vary depending on the environment of use.

► Cleaning of the fan filter

- Be sure to power off before cleaning the ionizer.
- Wash the filter in the running water.
- Completely dry the filter and insert it into the filter cover.
- In case the fan filter is severely damaged, replace it.

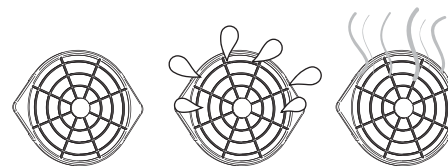

6 Problem solving

► Checklist before called

Problem	Confirmation Matter	Solution
The product does not work.	Is your power cable still plugged in?	Please re-plug the power cable and then turn the device on again.
	Was the proper voltage level applied for this set-up?	Please use the proper level of power input for the device. (AC 100~240V, 50/60Hz)
	Is the switch off at back of the device?	Turn on the power switch.
There is no ionization.	Is there any conductive material around the device?	Please refer to 'Installation & Connection,' for setting the proper target distance from the device.
	Does the installed environment have too high/low level of humidity or temperature?	Please install the device upon the proper working specification.
The ionizing performance has been decreased.	Can't possibly ground the device?	Please refer to 'Installation & Connection,' for(proper) grounding the device.
	Any damages or cut on the cables?	You need to replace the cables if it gets cut or damaged.
	Any contamination on the discharge needle?	Please refer to 'Maintenance,' for cleaning the discharge needle.

7 Dimensions

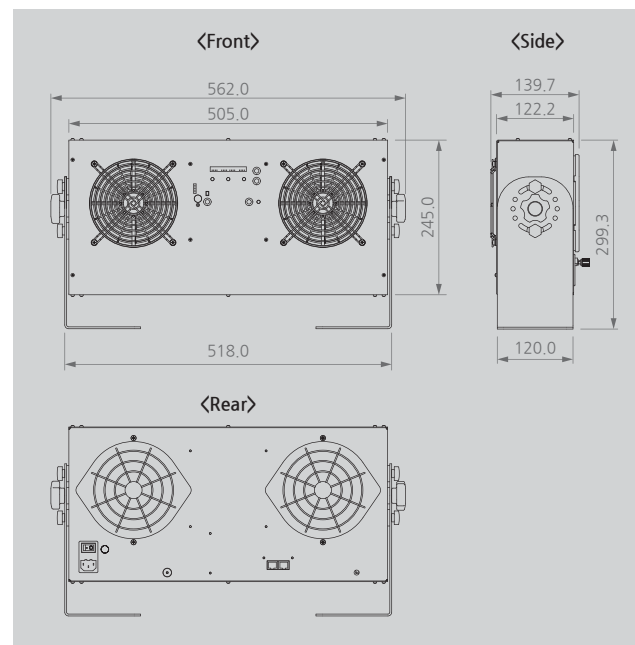

8 Specification

Parameter	Description / Value
Input Power	AC 100 ~ 240V, 50/60Hz
Ion-Generation Method	Steady-State DC
Power Consumption	50W (Fan Speed Max)
Current Consumption	227mA (AC 220V)
Air Flow	12.4m³/min (Fan Speed Max)
Noise Level(dB)	68dB (1000mm, Fan Speed Max)
Ion Balance	Within ±2V (600mm, Maximum Air flow)
Ozone(O3) Concentration	≤0.05ppm
Operation Circumstance	0°C ~ +50°C(32 F ~ 122 F), 35% ~ 85% RH
Weight	6.2Kg
Material	Aluminum
Electrode Material	Tungsten
Mounting Method	Desktop
Function	4 Step Fan Speed, Tip Cleaning, Auto Tip Cleaning
Alarm Function	Ion Unbalance Alarm, Fan Alarm
Interface	Remote On/Off, Run State, Alarm, Tip Cleaning, RS 485
Warranty	1 year

※ The appearance and specification of the product may be changed without prior notice for the improvement of the product.

SUNJE Hi-Tek Co., Ltd.

www.sunstat.com

Head Office & Factory (Busan)  
8 Cheonggwang-gil, Ilgwang-eup,  
Gijang-Gun, Busan, Korea  
T) +82-51-720-7500 F) +82-51-720-7501

Sunje (SHANGHAI) Trading Co.,Ltd.  
205B, Building A, No.1018 Mingzhu Road,  
Qingpu District, Shanghai, China  
T) +86-21-5433-9761 F) +86-21-5433-9762

Sales Headquarter (Osan)  
3rd floor, 129-20, Gyeonggi-daero 632  
beon-gil, Osan-si, Gyeonggi-do, Korea  
T) +82-31-203-9034 F) +82-31-202-9034

Sunje Technology Co., Ltd.  
2F, No.6, Lane.102, Sinhe Rd, Sinfong  
Township, Hsinchu County, Taiwan 30472  
T) +886-3-568-7891 F) +886-3-568-7950

Customer Center +82-70-7714-9033 Sales Contact +82-31-203-9034