

Instruction Manual **SUNJE**

SBL-18

Eng

It is recommended that only persons who have sufficient knowledge and experience such as system designers and responsible persons deal with this product after carefully reading the product manual.

1 The matters of safety

⚠ WARNING

- * If the equipment is used in a manner not specified by the manufacturer, the protection provided by the equipment may be impaired.
- * Do not let the water touch the product.
It may cause electric shock or fire due to malfunction.
- * When you check or maintain the product, make it sure you turn off the power.
It may cause electric shock or fire due to malfunction.
- * Secure the product firmly when you want to secure it.
There is a possibility of accident due to fall-over or malfunction, etc.
- * Do not use the product at the place where dangerous material such as inflammable or ignitable material exists. This product is not the product of anti-explosive type.
- * This device is made only for industrial uses. You need to ground the device beforehand. Otherwise, there are in case of malfunction, electric shock, or fire damage.

⚠ CAUTION

- * Do not contact the discharge needle or terminal with power applied.
There is a possibility of electric shock or malfunction.
- * Handle the discharge needle with care as its tip is very sharp.
- * Connect wires referring to the product manual.
Wrong connection can cause failures.
- * Take precautions as cables of the adaptor, the power line and communication line of each product may disconnect. If the cable is damaged, replace it immediately.
- * Do not install the device where the vibration can be detected. Any minor impact or vibration on the device, the malfunction or danger of accident might happen.
- * Do not use the product for the purpose outside of the range of the product use.
If the product is used for the purpose outside of the range of the use, it can result in the trouble or the shortened service life. Or an unexpected problem may occur.

2 Check the package contents

▶ Product compositions

The package includes the following products composition.

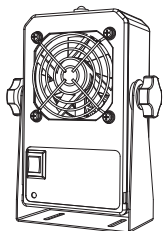

Ion Blower
SBL-18
1ea

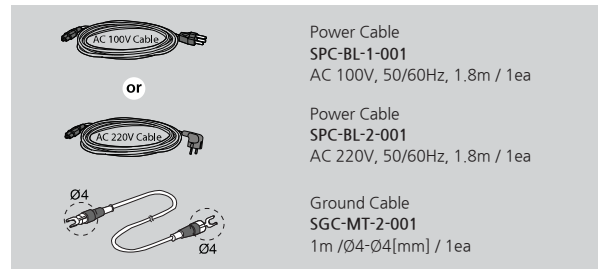

3 Nomenclatures of parts

Front

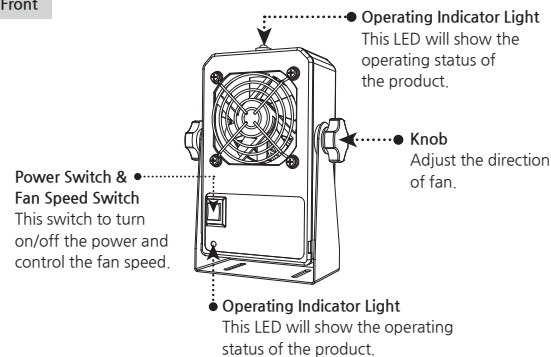

Rear

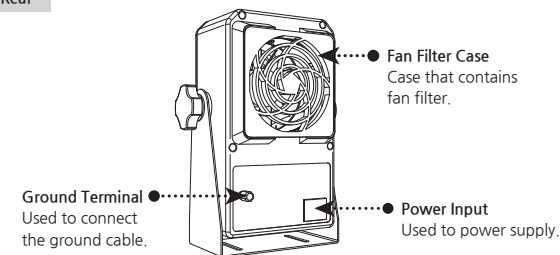

4 Installation and connection

⚠ WARNING

- * Please adjust the device in the proper position upon the area you install.
The item should be laid on the flat surface.
- * When installing the device, please be aware of high temperature / humidity.
- * If there are any random objects that are closely surrounded or touched the target object, the ionizing performance might decrease.
Please consider the area where you install.
- * The performance of device will decrease if the ground is insecurely connected.
The proper ground connection is always a first thing to consider.

▶ Caution for installation

How to basic installation

When installing products, you should leave a space of minimum 30mm on both sides and minimum 100mm on the back.

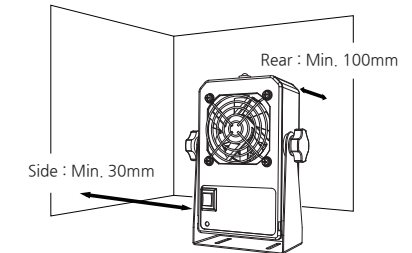

When installing more than two units

When installing more than two units of SBL-18, leave a space of minimum 100mm between products.

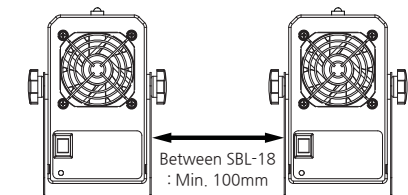

Installation against the target of de-electrification

Install the product with the distance of more than 100mm. When installed within 100mm, the phenomenon of reverse electrification can occur.

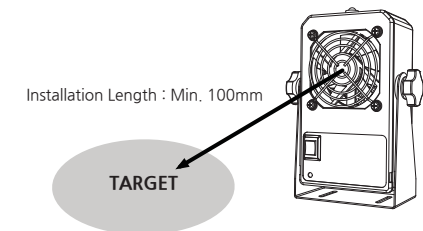

▶ Mounting method

Fix the mount at the place where you want the SBL-18 to be fixed using Ø5mm bolts(4ea).

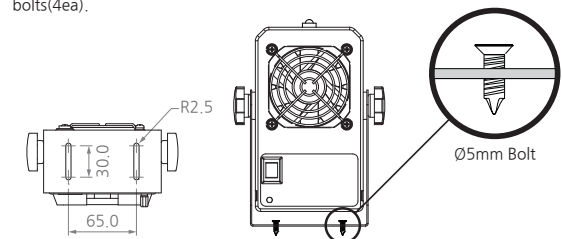

► How to connect

Refer to the figure below to connect the product.

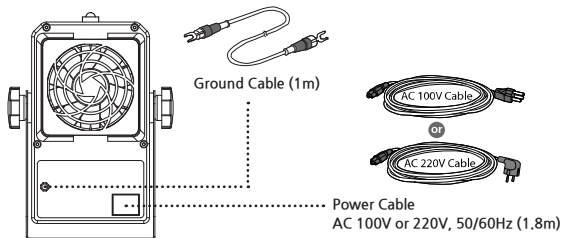

※ Be sure to ground the body of SBL-18 in order to secure the stable performance of the product and to prevent electric shock. Offers the power cable of AC 110V or AC 220V depending on the customer's choice.

5 Maintenance

Maintenance is an essential item for maintaining its capacity. Please conduct a routine maintenance according to the below description. The life time of a discharge needle can be a difference depending on using circumstance.

SBL-18 needs a routine maintenance and cleaning in case of bad circumstance. (high humidity or dust) Therefore, the discharge needle is recommended to be cleaned regularly. (At least once a month)

! CAUTION

- * This device uses the high level of voltage. When operating maintenance, please power off and unplug the device. Otherwise, there might be in case of electric shock or fire damage.
- * The discharge needle is very sharp at the edge. Do not physically(directly) touch the discharge needle.

► Separating fan filter case

- Be sure to power off before separating fan filter case.
- Rear fan filter case is separated by pulling press the top and bottom by hand.
- Perform the cleaning or replacing of the fan filter and the discharge needle.

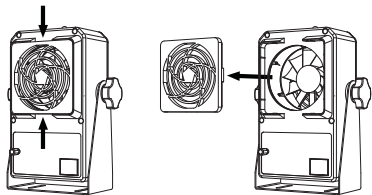

► Fan filter cleaning

- Be sure to power off before cleaning the ionizer.
 - Please remove the filter from the fan filter case of SMB-18's back side.
 - Wash the filter in the running water.
 - Completely dry the filter and insert it into the fan filter case.
 - In case the fan filter is severely damaged, replace it.
- ※ We recommend you to clean it once a week.

► Discharge needle cleaning

- Be sure to power off before cleaning the ionizer.
- Please separating fan filter case of a SMB-18's back side.
- Soak the cotton swab with alcohol. (do not use acetone)

- Put the swab on the discharge needle and wipe it turning the swab right and left. (take precautions not to apply severe force to the discharge needle.)
- Replace the damaged discharge needle.
- After the cleaning, let the alcohol applied to the discharge needle surface evaporate completely and then operate the SMB-18.
- Please record the cleaning process as a reference in the file.

► The cycle of replacing the electricity removal discharge needle

- Check during the discharge needle cleaning and take action.
- Replace the broken or severely damaged discharge needle.
 - The discharge needle is very sharp at the edge. Do not physically(directly) touch the discharge needle.
 - The general cycle of needle replacement is one year, however, it can vary depending on the environment of use.

6 Problem solving

► Checklist before called

Problem	Identifying Problem	Solution
The product does not work.	Is your power cable still plugged in?	Please re-plug the power cable and then turn the device on again.
	Was the proper voltage level applied for this set-up?	Please use the proper level of power input for the device. (AC 100~240V, 50/60Hz)
	Is the power switch off at front of the device?	Turn on the power switch.
There is no ionization.	Is there any conductive material around the device?	Please refer to 'Installation & Connection' for setting the proper target distance from the device.
	Does the installed environment have too high / low level of humidity or temperature?	Please install the device upon the proper working specification.
The ionizing performance has been decreased.	Can't possibly ground the device?	Please refer to 'Installation & Connection' for grounding the device.
	Any damages or cut on the cables?	You need to replace the cables if it gets cut or damaged.
	Any contamination on the discharge needle?	Please refer to 'Maintenance' for cleaning the discharge needle.

7 Dimensions

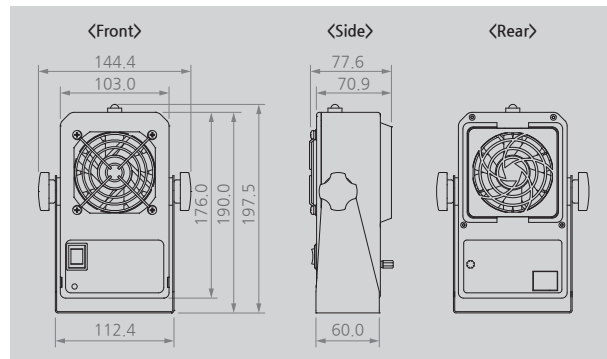

8 Specification

Parameter	Description / Value
Input Power	AC 110V/220V, 50/60Hz
Power Consumption	18W (Fan Speed : High operating)
Current Consumption	81mA
Ion-Generation Method	DC Type
Air Flow	1.9m ³ /min
Noise Level(dB)	54dB (1000mm)
Ion Balance	Within ±30V (600mm, Maximum Air flow)
Ozone(O ₃) Concentration	≤0.05ppm
Operation Circumstance	0°C ~ +50°C(32°F ~ 122°F), 35% ~ 85% RH
Weight	0.8Kg
Material	ABS
Electrode Material	Tungsten
Mounting Method	Desktop
Function	2 Steps Fan Speed
Warranty	1 year

※ The appearance and specification of the product may be changed without prior notice for the improvement of the product.

SUNJE Hi-Tek Co., Ltd.

www.sunstat.com

Head Office & Factory (Busan)
8 Cheonggwang-gil, Ilgwang-eup,
Gijang-Gun, Busan, Korea
T) +82-51-720-7500 F) +82-51-720-7501

Sunje Japan Co., Ltd.
Dai 7 Matsuya Bldg 10F 1005 2-23,
Honmachi-bashi, Chuo-ku, Osaka, Japan
T) +81-6-6949-5001 F) +81-6-6949-5011

Sales Headquarter (Osan)
3rd floor, 129-20, Gyeonggi-daero 632
beon-gil, Osan-si, Gyeonggi-do, Korea
T) +82-31-203-9034 F) +82-31-202-9034

Sunje (SHANGHAI) Trading Co.,Ltd.
Block C, 4F, No.482, Hongxu Road, Minhang
District, Shanghai, China
T) +86-21-5433-9761 F) +86-21-5433-9762

Customer Center +82-70-7714-9033
Sales Contact +82-31-203-9034

Sunje Technology Co., Ltd.
2F, No.6, Lane.102, Sinhe Rd, Sinfong Township,
Hsinchu County, Taiwan 30472
T) +886-3-568-7891 F) +886-3-568-7950