

Instruction Manual **SUNJE**

SXH-10SP1

Eng

It is recommended that only persons who have sufficient knowledge and experience such as system designers and responsible persons deal with this product after carefully reading the product manual.

1 The matters of safety

⚠ WARNING

- * Do not fabricate or do maintenance by yourself. Malfunction, Electric shock, and fire danger are considered. Contact us directly if you need the item to be repaired.
<A/S is not possible in case of arbitrary disassembly>
- * Do not let the water touch the product. It may cause electric shock or fire due to malfunction.
- * When you check or maintain the product, make it sure you turn off the power. It may cause electric shock or fire due to malfunction.
- * The item should be fixed to the target tightly. Electric discharging or breakage might happen.
- * Please shield your installing circumstances first since the item releases the soft X-ray. Direct X-ray exposure is not recommended owing to cause health problem.
- * It includes a beryllium window on the X-ray tube unit in order to release soft X-ray for ionization. This beryllium material can cause respiratory disorder only if the person gets exposed to forms of either beryllium powder or smoke. However, our device doesn't create beryllium in neither of the mentioned forms. Please be careful not to break the device since there might be a slight chance that the device could partially degrade into the powder form, then it can cause harm defects. If the user touches the beryllium material on the device, clean oneself on the running water or rinse it off with soap directly. If the beryllium window gets dirty or damaged, call us directly for assistance.
- * Do not use the product at the place where dangerous material such as inflammable or ignitable material exists. This product is not the product of anti-explosive type.
- * This device is made only for industrial uses. You need to ground the device beforehand. Otherwise, there are in case of malfunction, electric shock, or fire damage.

⚠ CAUTION

- * Do not disconnect the head cable with power applied. There is a possibility of electric shock or malfunction.
- * Connect wires referring to the product manual. Wrong connection can cause failures.
- * For your proper cable connection, take a look at the manual "Installation & Connection" for references. Any disordered connection is detected, the malfunction might arise.
- * All cables should be connected all the time. Please careful of cable disconnections. If power or communication cables got damaged, replace them immediately. Malfunction and fire danger may happen.
- * Do not install the device where the vibration can be detected. Any minor impact or vibration on the device, the malfunction or danger of accident might happen.
- * Do not use the item off the range of usage (Electrostatic elimination).
- * Malfunction or danger of accident may occur.
- * If you wish to discard the head unit of X-ray device, you need to report for disuse declaration to the institution(s) where they ask to. A proper declaration procedure is necessary in order to disuse X-ray device. Please contact to either Korea Institute of Nuclear Safety(KINS) or a safety supervisor of Sunje directly.

2 Check the package contents

▶ Product compositions

The package includes the following products composition.

- * Head SXH-10SP1 (Standard) 1~4 ea
- * Head SXH-10SP1-OP (Tube Replacable Type_Option) 1~4 ea
- * Fixing Bolt SFB-XN-1-001 1/4"-20unc x 15L / 1~4ea
- 1/4"-20unc x 8L / 1~4ea
- M4 x 0.7Pitch x 10L / 2~8ea

※ The SXH-10SP1 consists of two types: Standard type, Tube Replacable type)

▶ Option

If you require extra functions with the basic accessories we provided, you need to purchase optional items in below for further assistant.

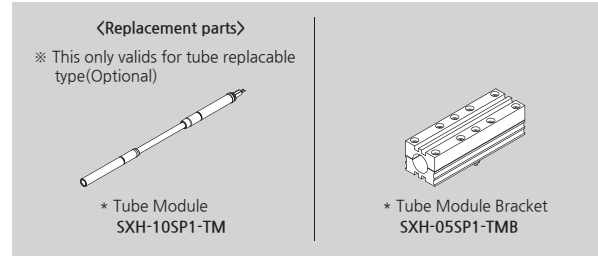

3 Nomenclatures of parts

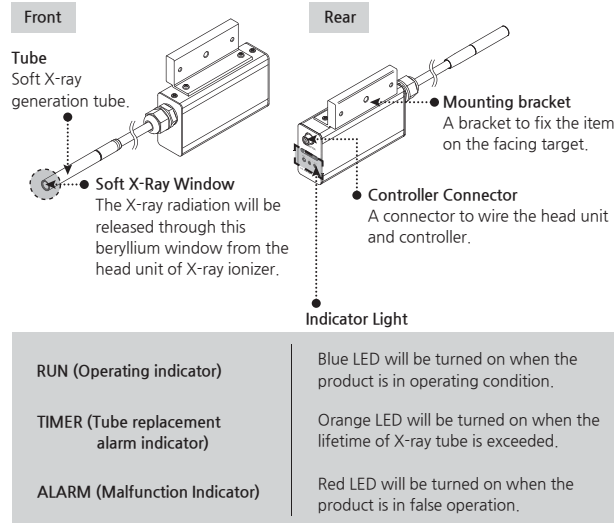
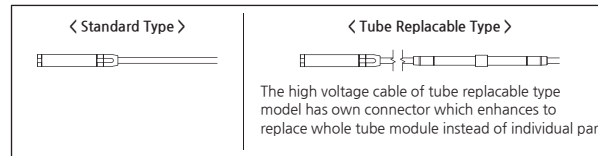

4 Installation and connection

▶ Check the installation conditions head unit

Please check the installation condition whether it meets proper specification.

- Shielded room
- There must be no objects between the target area and x-ray device.
- No vibration on the fixed device.
- Be aware of any flammable or ignitable materials around the working area.
- Secure to have enough working space for quick maintenance of the device.

▶ Head unit fixing

Fix the target product on the fixed area where you install by using supported fixing bolt(s).

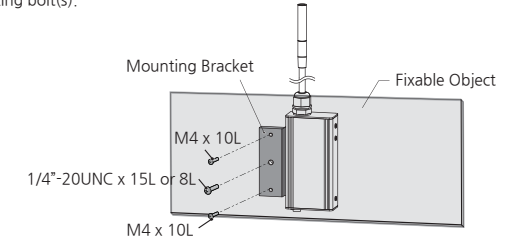

▶ Tube module bracket installation (Option)

Fix the target product on the fixed area where you install by using supported fixing bolt(s) or separate bolt(s).

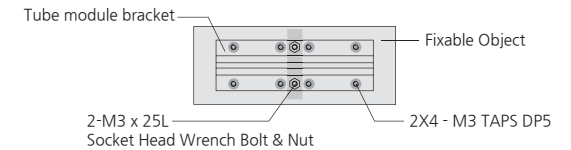

Precautions when installing the tube module bracket

※ Install the tube module bracket within 40mm of the irradiation window of the tube module. If the installation distance is wrong it can cause of malfunction, failures or fire damage.

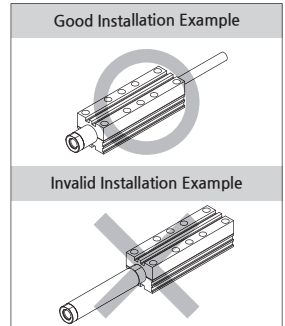
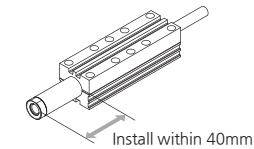

▶ Controller that can be connected with SXH-10SP1. And Functions

No.	Functions	Controller		
		SXC-104N	SXC-104S	SXC-104T
1	Product Monitoring(RS-485)	○	○	○
2	Resetting usage time after Head replacement	○	○	×
3	Stop when communication is not possible. (Function for Safety)	○	×	×
4	Checking the individual head position	○	×	×
5	Controlling the individual head	○	×	×
6	Number of Heads can be connected	1~4	1~4	1~4

► Shielding methods

Shielding Material Selection

See the following graph for references. Select the ideal tickness and quality of shielding material.

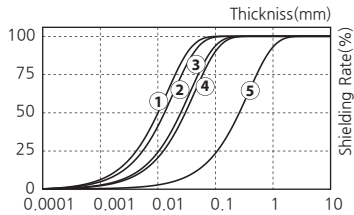

No.	Shield Material	Thickness [mm]
①	SUS	Over 0.3
②	Aluminium	Over 2.0
③	Glass	Over 4.0
④	PVC	Over 4.5
⑤	Acrylic	Over 40.0

WARNING

- * Please shield the area where the customer is willing to install the soft X-ray device for safety issue.
- * After shielding process, please connection to your own interlock system to operate the soft X-ray device on/off when the door is opened/closed.

► Shield installation compositions

Please refer to the "Installation Compositions" for your references. Please keep your working environment of the leakage radiation level within the range of 10 μ Sv/hr all the time.

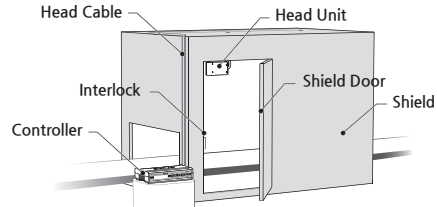

5 Problem solving

► Checklist before called

Problem	Identifying Problem	Solution
Not Operating	Is your cable still plugged in?	Please re-plug the cable and then turn the device on again.
	Is there any alarm LED on the head unit of device?	Purchase and replace the head unit.
	Is remote off?	Clear the remote off corresponding to "Remote Setup" manual.
	Is Interlock off?	Place Interlock on corresponding to "Interlock setup" manual.
	Have you followed the proper procedure for input/output signal cable(s)?	Check whether the cable connection is properly done.
Any damages or cut on the cables?	You need to replace the cables if it gets cut or damaged.	

6 Maintenance

* This only valids for tube replacable type(Optional).

WARNING

- * This device uses the high level of voltage. When operating maintenance, please power off and unplug the device. Otherwise, there might be in case of electric shock or fire damage.

► Tube Replacement

If there are any malfunction or lifetime excess on the tube, please purchase the new tube and replace it according to the following procedure.

CAUTION

- * When tube operates, heat is generated. Product is hot right after operation, so be careful not to touch it. There is a risk of burn.
- * When disassemble the module, please pull the connector horizontally in order not to break or damage the connector part. Please be careful when replacing tube module.
- * After replacement, check if tube module and Head body are connected correctly. Unless they are connected properly, ground could be unstable.

① Separating Tube Module

Please turn a coupler in the middle of connector counter-clockwise, then pull it out horizontally. Please discard tube module autonomously or contact us to disuse.

② Replacing New Tube Module

Place a new tube module horizontally and push it all the way to assemble back in, then turn a coupler clock-wise firmly.

< Tube Module Separation >

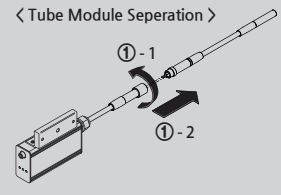

< Tube Module Combination >

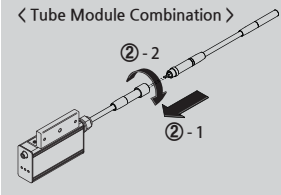

* Please implement the tube reset in a controller after replacing a tube. The newer tube might not work if you don't perform reset process.

7 Dimensions

SXH-10SP1 (Standard Type)

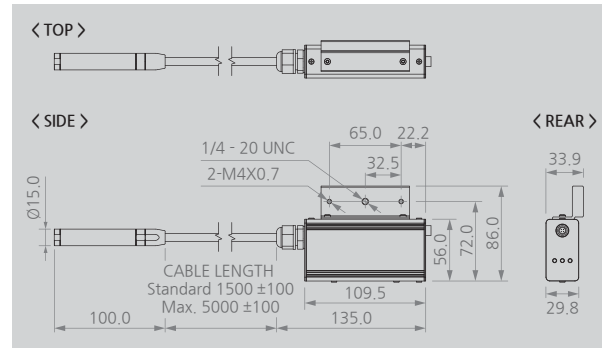

SXH-10SP1-OP (Tube Replacement Type_Option)

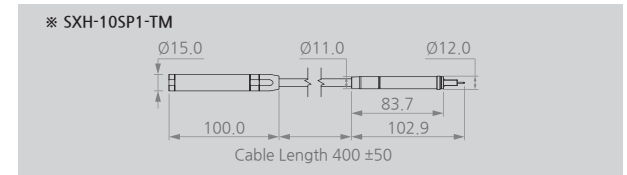
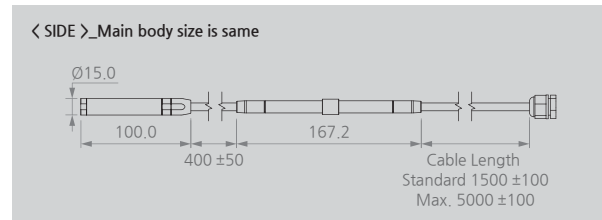

SXH-05SP1-TMB (Option)

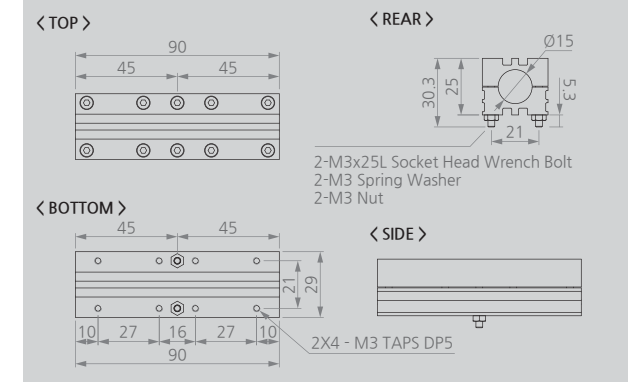

8 Specification

Parameter	Description / Value
Ion Generation Method	Soft X-ray
Source	Soft X-ray Tube
Tube Voltage	11kV
Beam Angle	150°
Power Consumption	Max. 10W (Based on 1 Head)
Operation Circumstance	0°C ~ +50°C(32°F ~ 122°F), 35% ~ 85% RH
Weight	SXH-10SP1 : 0.37kg SXH-10SP1-OP(Optional) : 0.46kg
Warranty	1 year

* The appearance and specification of the product may be changed without prior notice for the improvement of the product.

SUNJE Hi-Tek Co., Ltd.

www.sunstat.com

Head Office & Factory (Busan)

8 Cheonggwang-gil, Ilgwang-eup, Gijang-gun, Busan, Korea
T) +82-51-720-7500 F) +82-51-720-7501

Sunje Japan Co., Ltd.

Dai 7 Matsuya Bldg 10F 1005 2-23, Honmachibashi, Chuo-ku, Osaka, Japan
T) +81-6-6949-5001 F) +81-6-6949-5011

Sales Headquarter (Osan)

3rd floor, 129-20, Gyeonggi-daero 632 beon-gil, Osan-si, Gyeonggi-do, Korea
T) +82-31-203-9034 F) +82-31-202-9034

Sunje (SHANGHAI) Trading Co., Ltd.

Block C, 4F, No.482, Hongxu Road, Minhang District, Shanghai, China
T) +86-21-5433-9761 F) +86-21-5433-9762

Customer Center +82-70-7714-9033

Sales Contact +82-31-203-9034

Sunje Technology Co., Ltd.

2F, No.6, Lane.102, Sinhe Rd, Sinfong Township, Hsinchu County, Taiwan 30472
T) +886-3-568-7891 F) +886-3-568-7950